

NADAIR®
Since 1980



User Manual

Slim profile attachment kit



Model Number:
KIT-06-30-35-40-284

Index

- 1. Kit inclusion 3
- 2. High-voltage hose 4
- 3. Carpet beater specification 5
- 3. High-Voltage wand specification 5
- 5. How to use the carpet beater 6
- 6. Low-Voltage wand specification 7
- 7. Included cleaning tool 8
- 8. Easy Storage 9
- 9. Trouble shooting 8

1. INCLUDED IN THE KIT



1. High-voltage hose with dual control switch
2. Adjustable Low-Voltage wand
3. Adjustable High-Voltage wand
4. Electrical carpet beater
5. 12" Floor brush
6. Dusting Brush
7. Upholstery Brush
8. Crevice Tool
9. Accessory Bag
10. Chrome hose hanger

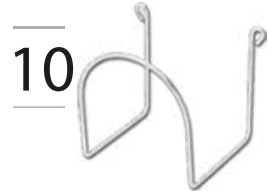
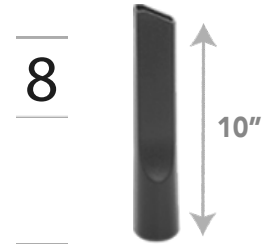
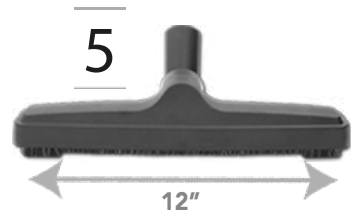
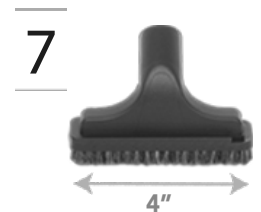
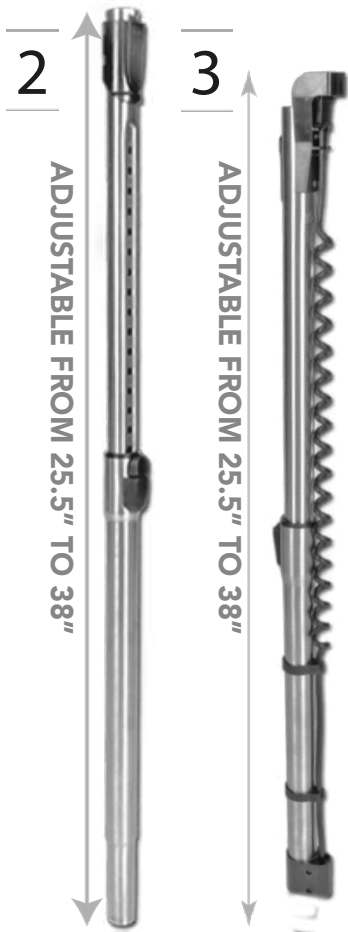

* Product dimensions may vary

2. HIGH-VOLTAGE HOSE

2.1 Compatibility

The hose is compatible with most wall inlets. Inlets must have a 1.5" inner diameter **(A)** in order for the hose to fit, and must have 2 low-voltage pins/metal prongs **(B)** in order to turn the vacuum ON and OFF from the switch located on the hose handle.

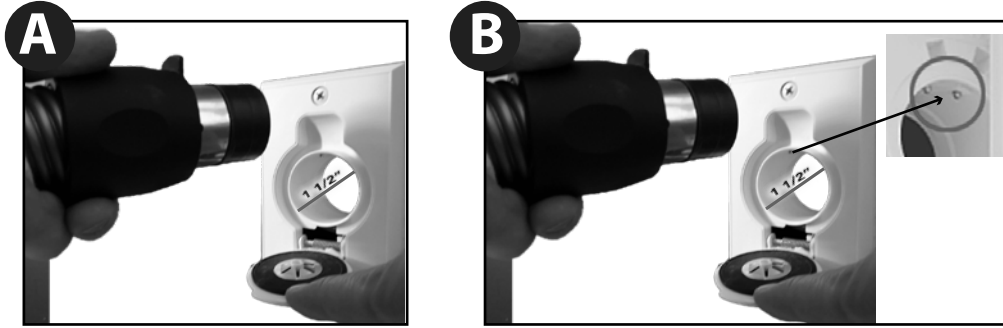

2.2 Connecting the hose to the wall inlet

The hose end cuff must be connected as shown in the picture below. The black part on the end cuff must be well aligned with the 2 pins inside the inlet **(C)**. The plastic square must be facing up **(D)**.

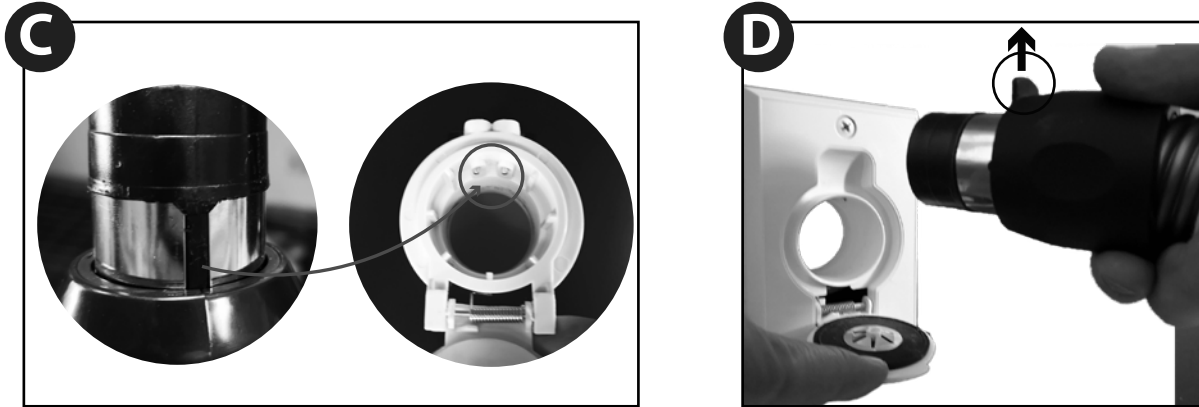

2.3 Dual switch control

1. Suction activation only: When using floor brush and accessories
2. Turn the unit off
3. Suction and carpet beater activation



2.4 72" pigtail (power cord)

The pigtail must be plugged into a standard 110-120 V outlet to power the electric carpet beater. The switch must be set to level II as demonstrated in step 2.3.

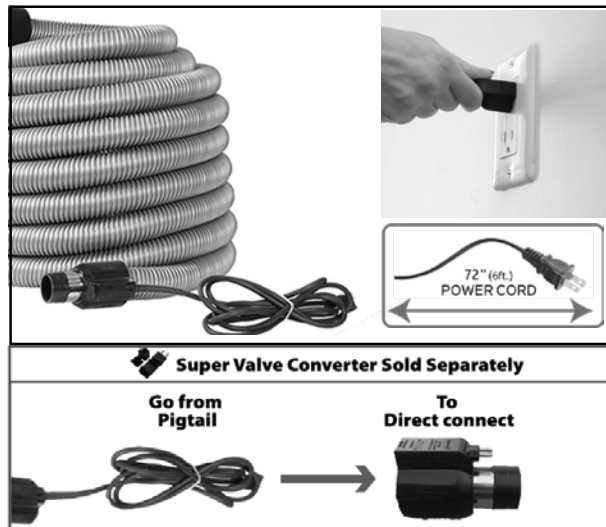

3. CARPET BEATER AND WAND SPECIFICATIONS

To remove the hose push on this button and pull on the the hose It will come out

To extended the wand, push this button at the same time.

Extend from 25.5" to 38"



To remove the wand push on this part with your foot and pull on the wand. It will come out



Slim profiles to fit under low furniture

To activate the carpet beater, simply put the hose switch on level 2 and the beater will automatically start



5. INSTRUCTIONS

Connecting the wand to the electric carpet beater

5.1 Carpet beater port



Wand port

The electric wand has female ports to connect to the electric carpet beater (powerhead).

5.2 Electrical wand port



Carpet beater (Powerhead) port

The electric carpet beater (powerhead) has male ports to connect to the electric wand.

5.3 Connection of the wand to the beater



Connection

To connect the wand to the electric carpet beater, align the female ports (from the wand) and the male connectors (from the carpet beater), then push the wand into the beater.

Connecting the high-voltage hose to the wand

5.4 Hose nozzle port



Hose port

The hose nozzle must have two female ports in order to connect it to the wand.

5.5 Electrical wand port



Wand ports

Our electric wand has 2 male ports.

5.6 Connection of the hose nozzle to the wand



Connection

Align the female ports from the hose nozzle with the male ports on the wand and push the hose nozzle into the wand.

6. LOW-VOLTAGE WAND

6.1 How to extend the wand

To extend the wand, simply push on the button **(E)** and pull on the wand **(F)** at the same time

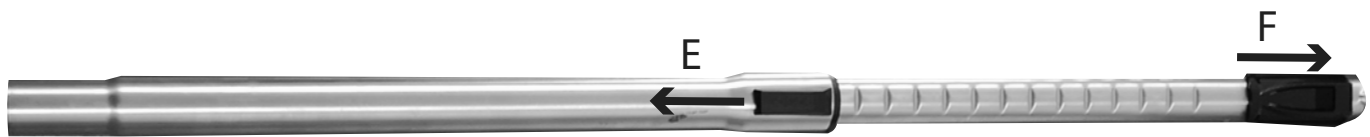

6.2 How to connect the wand to the hose nozzle

Align the hose nozzle button **(G)** with the lock button on the wand **(H)** and push the nozzle in the wand until you here a "click"

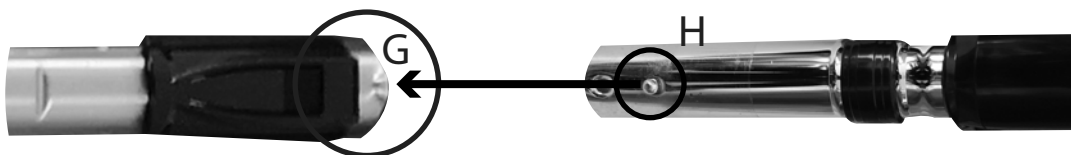

6.3 How to connect the different attachment tools

Insert the other end of the wand into the port on the brushes

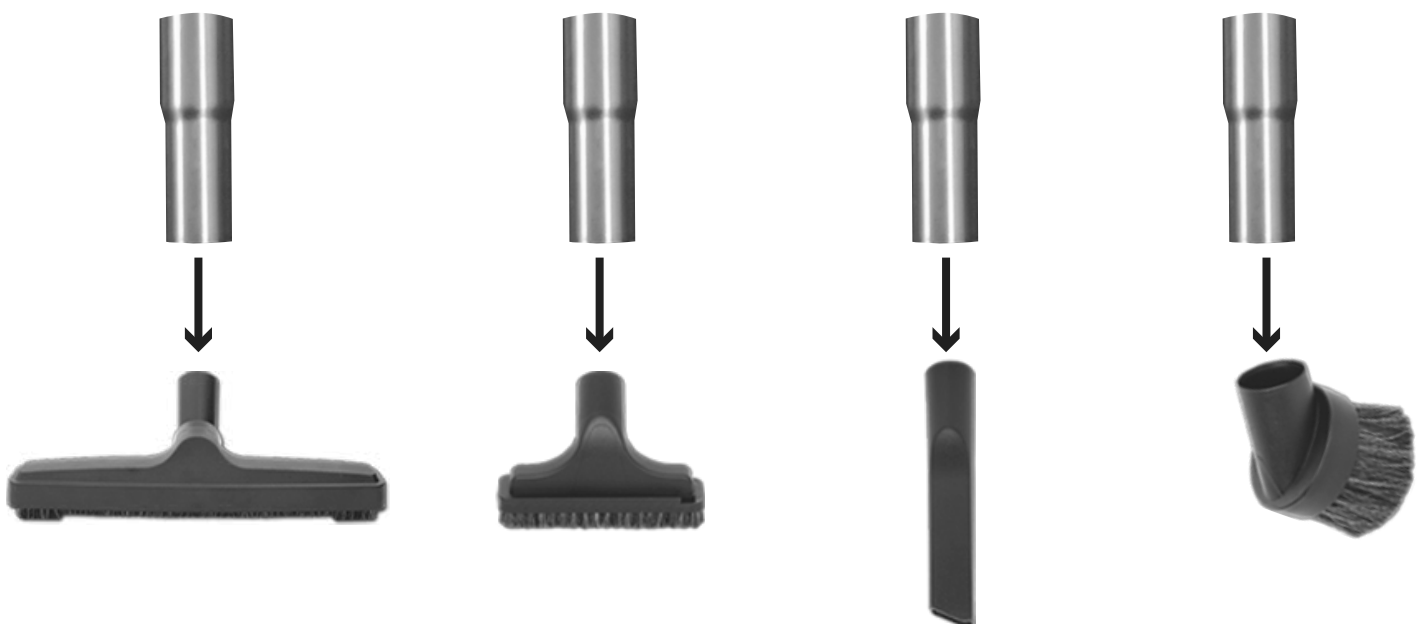

7. INCLUDED CLEANING TOOLS

7.1 12" Superior Floor brush

Ideal for hard surfaces. Made of horse hair - Will not scratch your floor

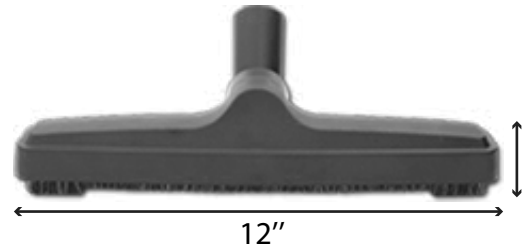

7.2 Dusting brush

Made of horse hair - Delicate and soft on furniture



7.3 Upholstery brush

Made of horse hair - Perfect for delicate furniture



7.4 Crevice tool

Ideal to clean cracks and crannies

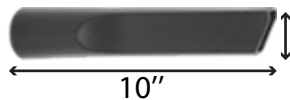

* Product dimensions may vary

8. EASY STORAGE INCLUDED

8.1 Chrome hose hanger

The perfect accessory to store your hose neatly.

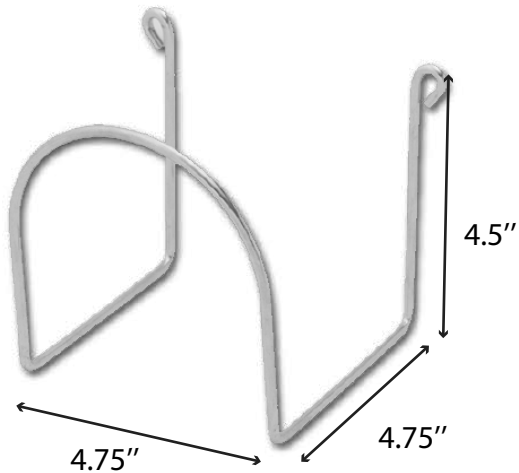

8.1 Accessory bag

Easily store your accessories without making a mess in your storage room.



* Product dimensions may vary

13. TROUBLE SHOOTING GUIDE

CHECK THESE FIRST

Service problems that appear to be major can often be solved easily. You can be your own troubleshooter by reviewing this guide.

Problem	Check	Solution
Power nozzle won't turn ON	• Hose power cord	• May not be properly connected. Plug hose firmly into receptacle on nozzle.
	• Belt	• Belt may be worn or broken. Check and replace if necessary
	• Switches	• Make sure surface selector switch and/or brushroll switch are both on.
	• Overload protection reset	• Make sure the overload protection button has been reset.
Power nozzle still does not operate properly	• Review all the above	• Contact your dealer for service.

NADAIR®

Since 1980



USA: www.nadair.com

Canada: www.nadair.ca

1 800 776-7891

TO REGISTER YOUR WARRANTY:

USA: nadair.com/vacuum/warranty-general/

Canada: nadair.ca/vacuum/warranty-general/

TO GET PARTS OR OTHER PRODUCTS:

USA: nadair.com

CANADA: nadair.ca

EMAIL AT: info@nadair.com

TOOL FREE: 1-800-776-7891

2044 Autoroute 440 Ouest, Laval, QC, H7S 2M9